

PCB MAX SIZE

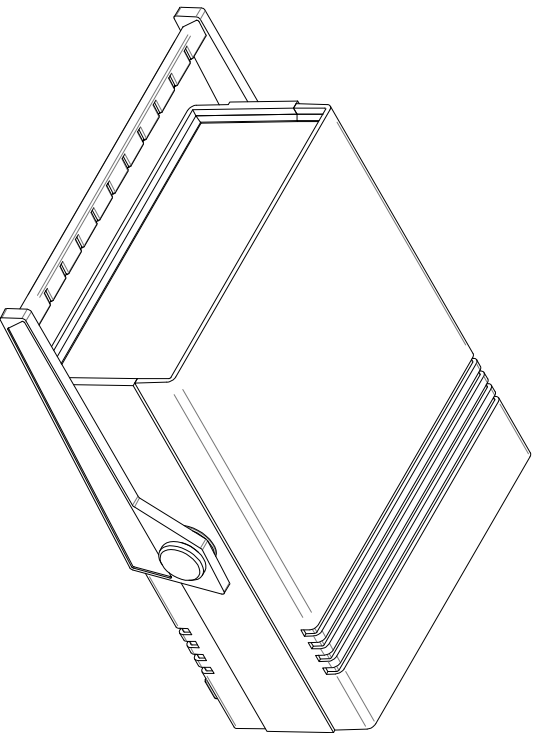
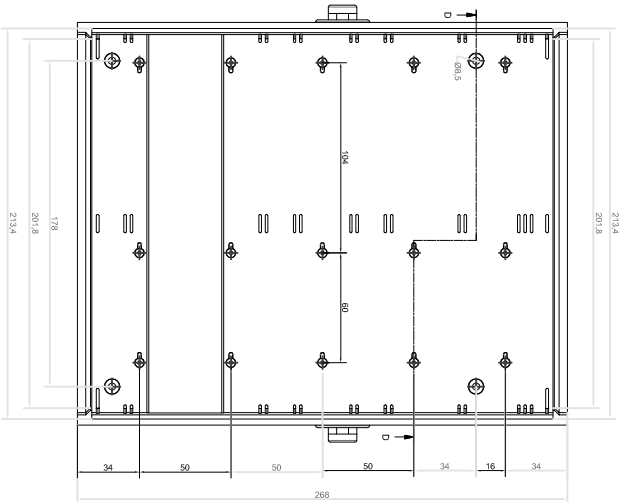
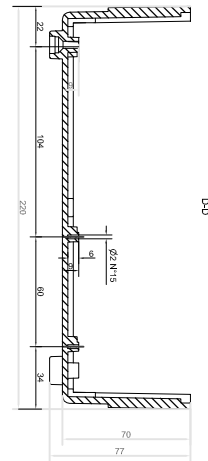
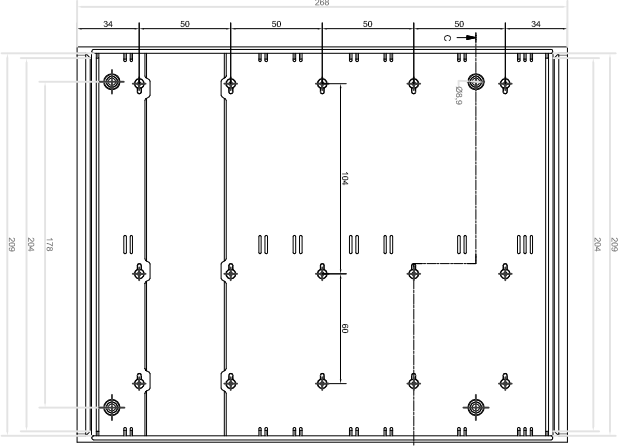
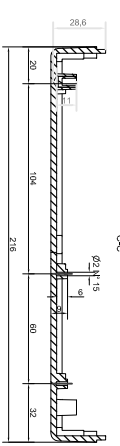
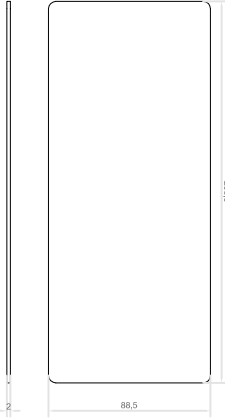
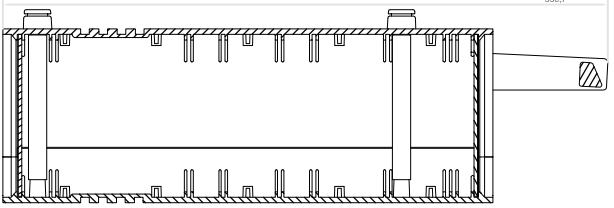
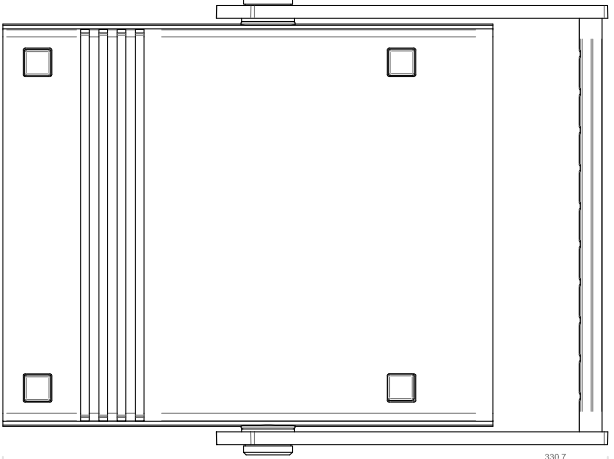
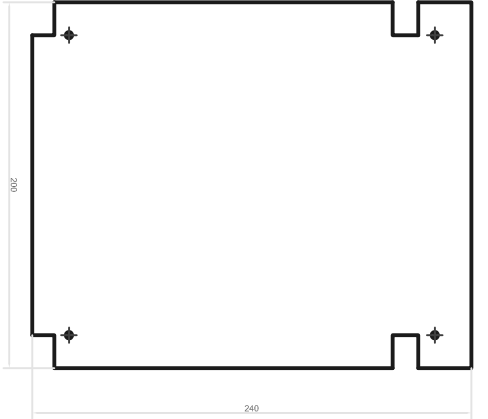

| | | |
|---|-----------------------------|-----------------------------|
| | Assembly 761 | 761 |
| <small>Subject to approval by the customer. All dimensions are in millimeters. All tolerances are in millimeters unless otherwise specified. For more information, please contact the manufacturer.</small> | | |
| <small>PCB MAX SIZE</small> | <small>PCB MAX SIZE</small> | <small>PCB MAX SIZE</small> |